

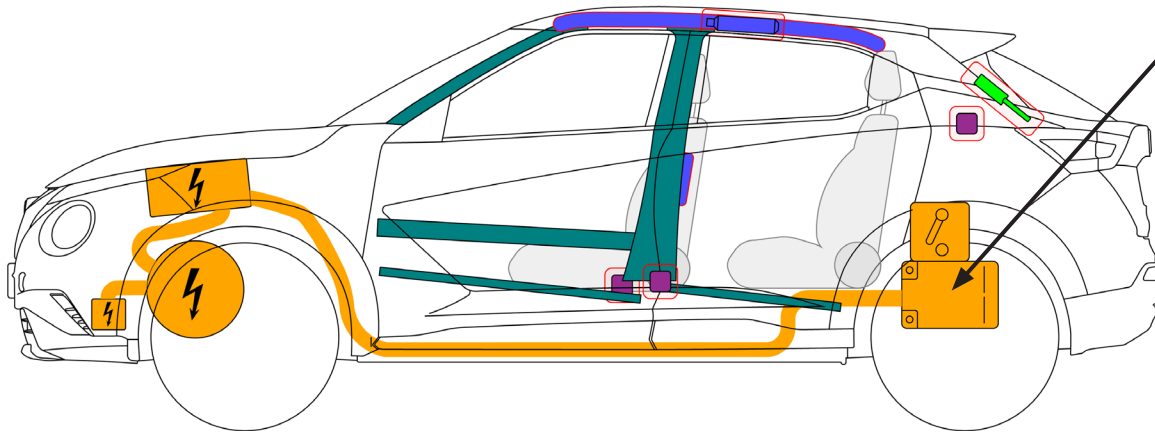

Nissan  
**Juke Hybrid**  
 Type: F16, 5-door SUV  
 (2022 - )

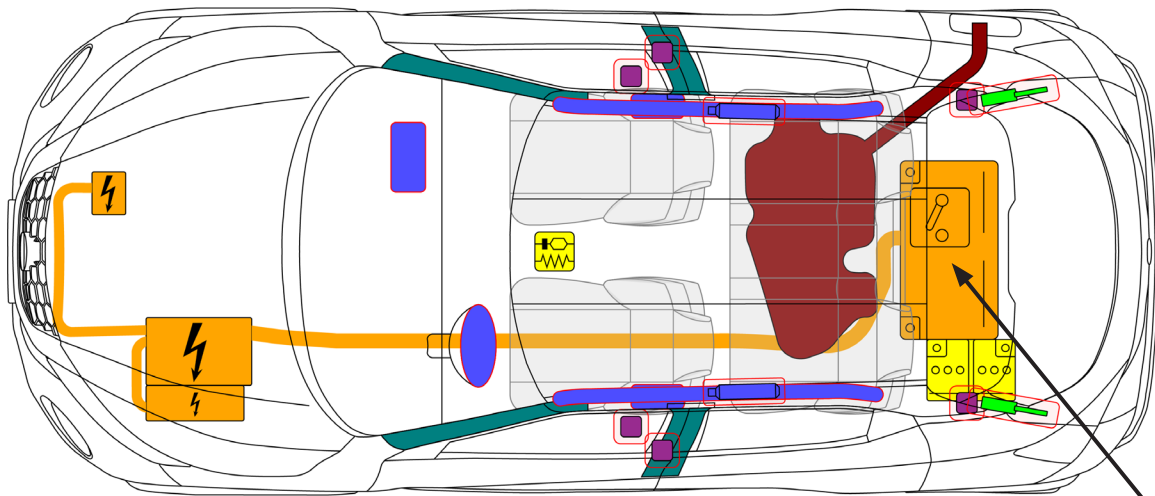

**286 V  
Li-ion**

Airbag	Stored gas inflator	Seat belt pretensioner	SRS control unit	Battery low voltage
Gas strut/preloaded spring	High strength zone	High voltage device that disconnects high voltage	High voltage component	Battery pack, high-voltage
High voltage power cable	Fuel tank content gasoline/ethanol			

## 1. Identification / recognition



LACK OF ENGINE NOISE DOES NOT MEAN VEHICLE IS OFF. SILENT MOVEMENT OR INSTANT RESTART CAPABILITY EXISTS UNTIL VEHICLE IS SHUT DOWN. WEAR APPROPRIATE PPE.

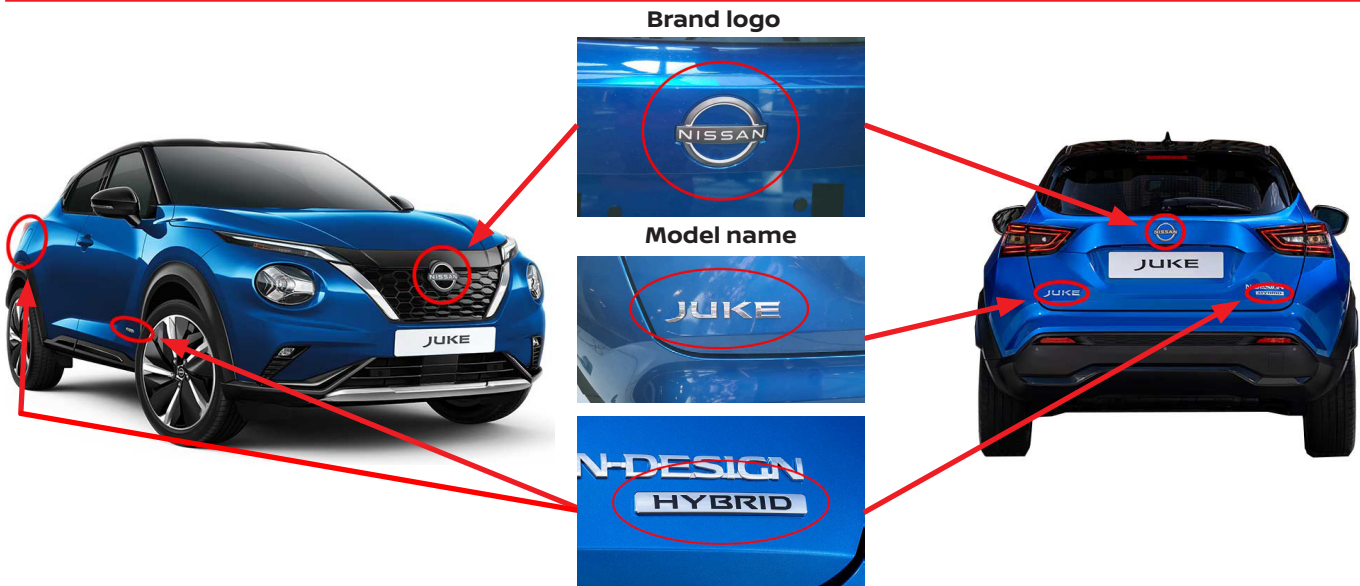



## 2. Immobilization / stabilization / lifting

### Immobilize vehicle:

1. Block wheels, apply brake and move gear selector to (P) park mode



### Lifting points:

-  Appropriate lifting points
-  High voltage battery

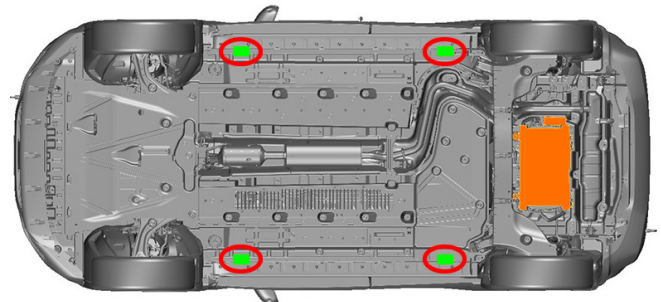

## 3. Disable direct hazards / Safety regulations



In case of a collision with seat belt pretensioner activation / airbag deployment, the high voltage system will be disabled automatically. The restraint systems are still active.

1. If the "Ready" indicator in the instrument cluster is illuminated press the Start/Stop button once. Then the high voltage system is disabled

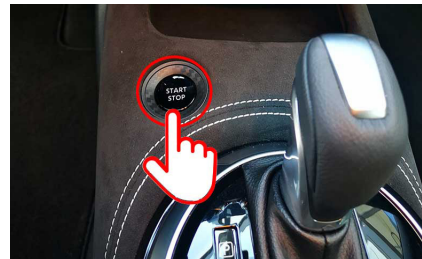
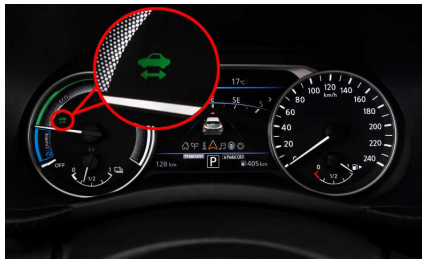

Then, remove the electronic key and keep at least 16 ft. (5 m) away from the vehicle

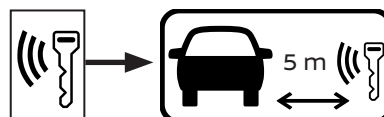

Access to the trunk



2. Disconnect 12 Volt battery

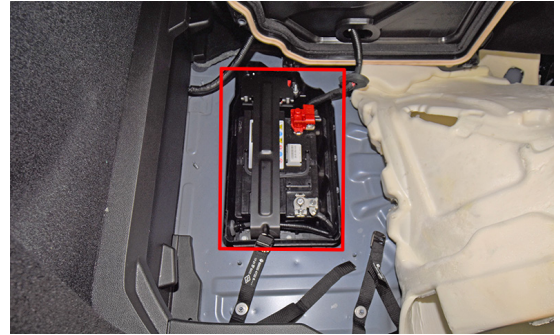
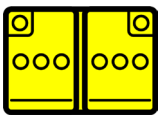

3. Deactivation of high voltage system, use class 0 insulating rubber gloves when operating this disconnect switch.

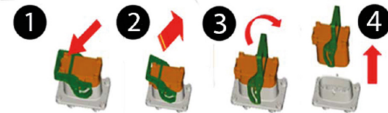
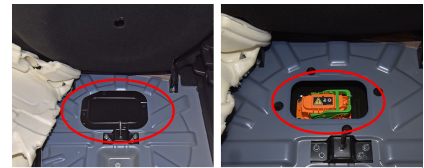
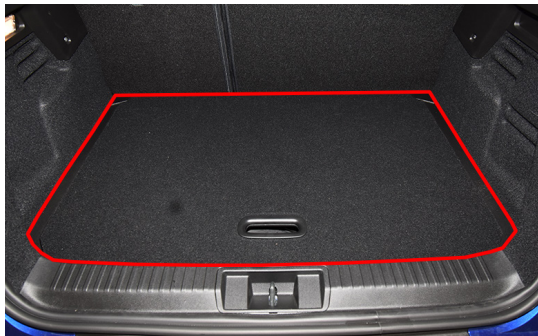
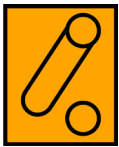

Safety instructions:

Never touch, cut, or open any orange high voltage power cable or high voltage component!

4. Acces to the occupants

High strength steel in body and door

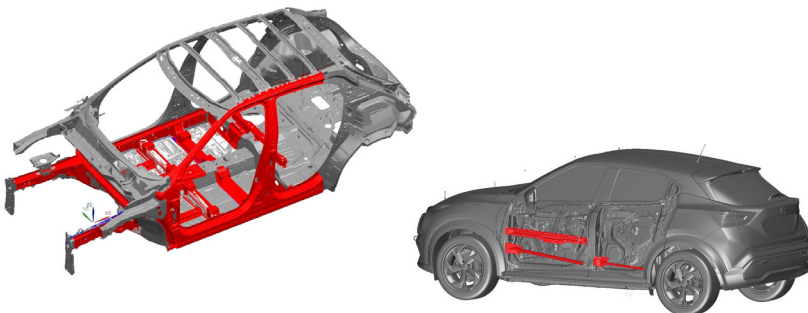

Steering column adjustment



**Nissan Juke HEV Type: F16, 5dr SUV (2022 - ) – Additional Pages**

**Seat adjustment**

















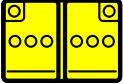



**Glass types**

- A. Laminated glass
- B. Tempered glass



**5. Stored energy / Liquids / Gases / Solids**

	<b>Lithium-ion 150-286V</b>						
	<b>12V</b>						
	<b>R-1234yf 500 25 g</b>						
	<b>46L</b>						

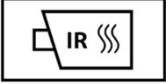
 When conventional coolant leaks (check reservoir) from the high voltage (HV) battery cooling system, HV-battery can become unstable with risk of thermal runaway. An increasing HV-battery temperature might be an indicator of thermal runaway. 

**6. In case of fire**

 **USE LARGE AMOUNTS OF PURE WATER**



**POTENTIAL RISK OF HV-BATTERY FIRE RE-IGNITION / DELAYED FIRE!** 

 Responders should always protect themselves with Personal Protective Equipment (PPE), including a Self-Contained Breathing Apparatus (SCBA), and take appropriate measures to protect civilians downwind from the incident.

 **GAS STRUT, RISK OF MISSILE EFFECT**



**7. In case of submersion**

- There is no increased risk of electric shock in water resulting from the high voltage system
- If possible, remove the vehicle from the water and continue with the deactivation procedure for this vehicle (see chapter 3)

**8. Towing / transportation / storage**

**Recovery hook storage**



**Location front hook**



**Location rear hook**



**Towing**



**STORE VEHICLE IN AN OPEN-AIR PARKING AT A SAFE DISTANCE  $\geq$  5M FROM OTHER OBJECTS OR VEHICLES!**

**POTENTIAL RISK OF HV-BATTERY FIRE RE-IGNITION / DELAYED FIRE!**



**10. Explanation of pictograms used**

	Remove smart key		Hybrid Electric Vehicle on fuel of liquid group 2
	Warning high voltage		Flammable
	Caution		Hazardous to the human health
	Warning; low temperature		Acute toxicity
	Air-conditioning component		Explosive
	Use water to extinguish the fire		Corrosives
	Use thermal infrared camera		Boot